



**KINEMATICA**

Homogenizing perfected.

**MICROTRON®**



MICROTRON® SYSTEM MB 950 G  
MICROTRON® SYSTEM MB 950 S  
Instruction Manual

**Garantie  
Warranty  
Upgrade**









**Jetzt registrieren / Register now:**  
[kinematica.ch/garantie-upgrade](http://kinematica.ch/garantie-upgrade)  
[kinematica.ch/warranty-upgrade](http://kinematica.ch/warranty-upgrade)











System	MICROTRON®		
Type	MB 950 G / S		
Version	1.1 / 19.06.2023		
Page	2	of	32

## SAFETY INDICATIONS











Please pay attention to the meaning of the following warning signs:

	CAUTION! SAFETY INSTRUCTIONS MUST BE OBSERVED TO ENSURE SAFE OPERATION.
	CAUTION! THIS SYMBOL INDICATES HIGH VOLTAGE, WITH RISK TO HEALTH AND ENVIRONMENT.
	CAUTION! BEWARE OF HOT SURFACE.
	CAUTION! BEWARE OF HAZARDOUS CHEMICALS OR MATERIALS THAT ENDANGER HEALTH
	CAUTION! BEWARE OF ROTATING MECHANICAL PARTS.
	CAUTION! DEVICE NOT DESIGNED FOR USE IN EXPLOSION ENDANGERED ENVIRONMENTS.
	CAUTION! BEWARE OF MOVING PARTS. NEVER PUT YOUR HANDS OR FINGERS IN BETWEEN. CRUSHING HAZARD.
	CAUTION! DANGER BY PRESSURIZED PARTS.
	CAUTION! RISK OF STUMBLING.









## GENERAL SAFETY INSTRUCTIONS

	RESPECT THE INSTRUCTIONS GIVEN IN THIS DOCUMENT.
	READ THESE OPERATING INSTRUCTIONS BEFORE SWITCHING ON OR OPERATING THE EQUIPMENT.
	IF YOU HAVE ANY QUESTIONS OR DOUBTS REGARDING OPERATING THE UNIT, DO NOT START OR OPERATE THE UNIT AND CONTACT YOUR DEALER OR NEAREST KINEMATICA SERVICE CENTER.
	IMPROPER USE OF THE UNIT DUE TO UNAUTHORIZED PERSONNEL CAN LEAD TO DAMAGE ON THE UNIT AND / OR ENDANGER LIFE, CAUSE PERSONAL INJURY AND HARM THE ENVIRONMENT.
	ALL AUTHORIZED PERSONNEL INVOLVED IN THE OPERATION, THE SERVICE OR THE REPAIR OF THE UNIT HAVE TO READ AND TO UNDERSTAND THIS MANUAL.
	ONLY AUTHORIZED PERSONNEL / INTENDED USERS ARE ALLOWED TO USE THE UNIT.
	THE INTENDED USER ASSURES THAT THE UNIT WILL BE INSTALLED CORRECTLY IN ORDER TO FULFILL THE INTENDED APPLICATION AND AUTHORIZES OTHER QUALIFIED USERS TO WORK WITH THE UNIT. HE IS ALSO RESPONSIBLE TO INSTRUCT THE USERS OF THE UNIT.
	THE SERVICE ENGINEER IS EMPLOYED BY THE INTENDED USER AND MAINTAINS THE UNIT DURING OPERATION. HE IS A SKILLED CRAFTSMAN WITH MECHANICAL, ELECTRICAL AND ELECTRONIC EDUCATION. THE SERVICE ENGINEER IS RESPONSIBLE FOR THE INSTALLATION AND START-UP OF THE UNIT AS WELL AS FOR THE MAINTENANCE AND REPAIR OF THE UNIT. HE MUST BE TRAINED ACCORDINGLY TO CARRY OUT ALL NECESSARY MAINTENANCE WORK.
	ENSURE THAT ALL LEGAL AND ENVIRONMENTAL REGULATIONS OF THE COUNTRY WHERE THE UNIT WILL BE INSTALLED ARE FOLLOWED.
	DO NOT MODIFY THE UNIT WITHOUT A WRITTEN CONFIRMATION BY KINEMATICA.

System	MICROTRON®		
Type	MB 950 G / S		
Version	1.1 / 19.06.2023		
Page	4	of	32











	IT IS STRICTLY FORBIDDEN TO RUN THE UNIT WITH DISASSEMBLED OR BRIDGED SAFEGUARDS, FOR EXAMPLE SAFETY LIMIT SWITCH, EMERGENCY SWITCH OR COVER.
	FOR REPAIRS, ONLY ORIGINAL SPARE PARTS SHOULD BE USED.
	BEFORE STARTING INSPECTION AND MAINTENANCE WORK ON THE UNIT (SERVICE, REPAIR ETC.), ALL POWER SUPPLIES MUST BE DISCONNECTED.
	THE DRIVE UNIT MAY ONLY BE OPENED BY AUTHORIZED KINEMATICA SERVICE STATIONS.
	SERVICE AND MAINTENANCE SHALL ONLY BE PERFORMED BY AUTHORIZED AND SKILLED SERVICE ENGINEERS.
	AFTER EVERY INSPECTION AND MAINTENANCE WORK ON THE UNIT (SERVICE, REPAIR ETC.) THE SERVICE ENGINEER HAS TO DO A TEST-RUN.
	EAR PROTECTION SHOULD ALWAYS BE USED WHEN WORKING IN THE ENVIRONMENT OF THE UNIT.
	KEEP THIS OPERATING MANUAL NEARBY THE EQUIPMENT FOR FUTURE REFERENCE.
	THIS DOCUMENT IS PART OF THE MACHINE / UNIT AND SHOULD NOT BE REMOVED OR STORED ELSEWHERE. EASY ACCESS TO THE OPERATING AND MAINTENANCE CREW MUST BE GRANTED AT ALL TIMES.
	ALTHOUGH KINEMATICA EQUIPMENT IS DESIGNED FOR EASY USE, THIS DOES NOT RELEASE YOU FROM THE OBLIGATION TO INSPECT YOUR EQUIPMENT CAREFULLY AND TO CLEAN IT THOROUGHLY.

## WARNINGS











	ALL WARNINGS AND RECOMMENDATIONS IN THE FOLLOWING CHAPTERS MUST BE RESPECTED!
	THE EQUIPMENT MAY NOT BE OPERATED IN EXPLOSIVE ENDANGERED AREAS. IT IS NOT ALLOWED TO WORK WITH FLUIDS WHICH ARE HIGHLY INFLAMMABLE. IT IS NOT ALLOWED TO MIX MATERIALS WHICH CAN CAUSE STRONG EXOTHERMAL REACTIONS.
	THE ELECTRICAL INSTALLATION MUST BE DONE BY A QUALIFIED ELECTRICIAN !
	ENSURE THAT THE RATED VOLTAGE OF THE EQUIPMENT MATCHES THE SUPPLY.  IT IS IMPORTANT THAT THE MAINS SUPPLY WHERE THE DEVICE IS PLUGGED IN COMPLIES WITH THE INFORMATION ON THE TYPE LABEL AND THE INTERNATIONAL STANDARDS FOR POWER SUPPLIES. IF NOT, SUCCESSFUL OPERATION CANNOT BE GUARANTEED
	FOR SAFETY REASONS THE OUTLET MUST HAVE A FAULTY-ENERGY-PROTECTION SWITCH (FI).
	THE PLUG SHOULD ONLY BE PLUGGED INTO A SOCKET WHEN THE UNIT IS SWITCHED OFF. DO NOT TOUCH PLUG CONTACTS. DO NOT ALLOW THE MAINS CABLE TO HANG DOWN. NEVER ATTEMPT TO PULL OUT THE PLUG BY THE CABLE OR WITH WET HANDS. DO NOT ALLOW THE MAINS CABLE TO HANG OVER A SHARP EDGE OF A TABLE, DO NOT ALLOW IT TO LIE ON A WORK SURFACE, AND AVOID HAVING IT COME INTO CONTACT WITH HOT SURFACES.
	ENSURE THAT ENOUGH FREE SPACE IS AVAILABLE AT THE BACKSIDE OF DEVICE, SO THAT EFFECTIVE AIR FLOW AND COOLING IS ASSURED. INSUFFICIENT COOLING MAY LEAD TO A DECREASE OF POWER OUTPUT.
	THE DEVICE HAS TO BE PLACED IN A MANNER THAT DIRT OR FLUIDS CANNOT PENETRATE THROUGH THE VENTILATION SLOTS OF THE DRIVE.



System	MICROTRON®		
Type	MB 950 G / S		
Version	1.1 / 19.06.2023		
Page	6	of	32

	THE BLENDER SHOULD NEVER RUN WITHOUT MIXING ATTACHMENT.
	NEVER PUT A CUTTER ASSEMBLY ON THE MOTOR BASE WITHOUT THE VESSEL!
	ONLY FIT OR REMOVE THE MIXING ATTACHMENT WHEN MOTOR IS STATIONARY.
	THE CUTTER BLADES ARE SHARP AND MAY CAUSE BAD INJURIES.
	DO NOT TOUCH, NOR WITH ANY OTHER OBJECT, THE ROTATING COUPLING PIECE ON TOP OF THE MOTORBASE.
	NEVER USE THE UNIT WITHOUT HAVING THE SAFETY HUT (MB 950 G) OR LID (MB 950 S) PROPERLY IN PLACE. HOLD THE LID BY HAND DURING OPERATION! DANGER OF SCALDING FROM HOT PRODUCTS!
	TO AVOID HEAVY INJURIES OR DAMAGES OF THE UNIT, IT IS FORBIDDEN, WHILE MIXING TO REACH INTO THE MIXING ATTACHMENT WITH HANDS OR WITH A HARD SOLID OBJECT. THIS IS ALTHOUGH VALID BY A STANDING STILL MOTOR AND ASSEMBLED MIXING ATTACHMENT, IN CASE OF UNINTENTIONAL SWITCHING. DO NOT REACH INTO THE MIXING ATTACHMENT WITH A HARD SOLID OBJECT BY OPENING THE LID LOCK.
	THE INTENDED USER HAS TO ENSURE THAT USED SOLVENTS AND CLEANING MATERIALS ARE COMPATIBLE WITH THE MATERIAL OF THE SEALS AND COMPONENTS OF THE UNIT
	IN THE EVENT THAT HAZARDOUS CHEMICALS OR MATERIALS THAT ENDANGER HEALTH CAN INFLUENCE THE SURROUNDINGS OR USE OF THE EQUIPMENT, APPROPRIATE COUNTERMEASURES MUST BE TAKEN.
	WHEN HANDLING DANGEROUS PRODUCTS, TAKE CARE THAT THE LOCAL SAFETY REGULATIONS ARE RESPECTED.









System	MICROTRON®		
Type	MB 950 G / S		
Version	1.1 / 19.06.2023		
Page	7	of	32

	<p>IF THE UNIT IS USED FOR ANY OTHER PURPOSE THAN THE INTENDED APPLICATION OR IF THE UNIT WILL BE OPERATED BEYOND THE TECHNICAL DATA RANGE WITHOUT THE WRITTEN APPROVAL BY KINEMATICA, IMPROPER USE IS DECLARED AND KINEMATICA WILL TAKE NO RESPONSIBILITY, NOR WILL GRANT ANY GUARANTEE.</p> <p>IMPROPER USE OF THE UNIT CAN RESULT IN PERSONAL INJURY OR IN DAMAGE OF THE EQUIPMENT. KINEMATICA WILL NOT BE LIABLE AND WILL TAKE NO RESPONSIBILITY IN SUCH AN EVENT.</p>
	<p>REPAIRS ON ELECTRICAL UNITS SHOULD ONLY BE CARRIED OUT BY PROFESSIONAL TECHNICIANS. USE ONLY ORIGINAL SPARE PARTS. SERIOUS DANGERS TO THE USER COULD RESULT FROM IMPROPER CARRIED OUT REPAIRS.</p>
	<p>TO ENSURE THAT THE UNIT IS SAFELY SWITCHED OFF, THE POWER PLUG MUST BE PULLED OUT.</p>
	<p>ATTENTION! IF THE UNIT'S MAINS CABLE SHOULD BECOME DAMAGED, IT SHOULD ONLY BE REPLACED WITH AN ORIGINAL CABLE.</p>
	<p>WHEN THE MACHINE STOPS AUTOMATICALLY, IMMEDIATELY REMOVE THE MIXING ATTACHMENT, PULL OUT THE POWER PLUG AND WAIT FOR 1 MINUTE.</p>
	<p>IF THE UNIT HAS BEEN DROPPED OR HAS FALLEN, TAKE IT TO AN AUTHORIZED SERVICE CENTER FOR INSPECTION.</p>
	<p>DANGER! THOROUGHLY CLEAN THE UNIT AFTER USE EVERY TIME. INCORRECT AND CARELESS CLEANING HEIGHTEN THE RISK OF GROWING MICRO-ORGANISMS.</p>
	<p>THE MOTOR UNIT MUST NEVER BE SUBMERGED IN, OR SPRAYED WITH WATER OR ANY OTHER LIQUID! NEVER ATTEMPT TO CLEAN IT WITH A WATER JET! CLEANING OF THE INSIDE SHOULD ONLY BE MADE AT AN AUTHORIZED SERVICE CENTER.</p>
	<p>BE SURE THAT THE MOTOR CANNOT BE STARTED FROM ANOTHER PERSON, WHILE YOU ARE WORKING.</p>
	<p>BE SURE THAT THE MOTOR CANNOT BE STARTED FROM ANOTHER PERSON, WHILE YOU ARE WORKING.</p>

INSTRUCTION MANUAL			
System	MICROTRON®		
Type	MB 950 G / S		
Version	1.1 / 19.06.2023		
Page	8	of	32

## RESIDUAL DANGERS

When the system/equipment is used in accordance with rules and regulations, residual dangers are minimal.

Residual danger	Countermeasures
 <p>Tripping over feed or return or supply lines, piping</p>	These should be laid appropriately.
 <p>Breakage of piping</p>	Wear protective clothing (goggles etc.).   
  <p>Leakage of product or other supply</p>	
 <p>Hearing loss due to loud noise</p>	According to the application ear protection must be used.  
 <p>Tilting of the device</p>	Use stable, non-slip base.



INSTRUCTION MANUAL			
System	MICROTRON®		
Type	MB 950 G / S		
Version	1.1 / 19.06.2023		
Page	9	of	32

## Table of Contents

1	INTRODUCTION .....	10
2	DESCRIPTION OF THE UNIT .....	11
2.1	DRIVE UNIT MB 950 G / MB 950 S .....	12
2.1.1	<i>SAFETY CONTROL AND MOTOR PROTECTION</i> .....	13
2.1.2	<i>CONTROL AND DISPLAY ELEMENTS</i> .....	14
2.2	MIXAUFSÄTZE MBA .....	19
2.2.1	<i>MBA FOR MB 950 G</i> .....	19
2.2.2	<i>MBA FOR MB 950 S</i> .....	20
2.3	SAFETY HUT MBH .....	21
3	INSTALLATION AND START-UP .....	22
3.1	INSTALLATION .....	22
3.1.1	<i>MECHANICAL INSTALLATION</i> .....	22
3.1.2	<i>ELECTRICAL INSTALLATION</i> .....	22
3.2	START-UP .....	23
4	CLEANING .....	25
5	MAINTENANCE WORK .....	28
5.1	REPAIR .....	28
5.2	DISPOSAL / RECYCLING .....	28
6	SPARE PARTS .....	29
7	FAULTS AND REMEDIES .....	29
8	TECHNICAL DATA .....	31
8.1	DRIVE UNITS .....	31
9	WARRANTY .....	32

INSTRUCTION MANUAL			
System	MICROTRON®		
Type	MB 950 G / S		
Version	1.1 / 19.06.2023		
Page	10	of	32

## 1 INTRODUCTION

**KINEMATICA** is a specialist for design and manufacturing of dispersing and mixing machines. The aim of this document is to instruct new users in the effective and safe utilization of our equipment.

The Kinematica batch mixing systems **MICROTRON® MB 950 G** and **MICROTRON® MB 950 S** have been designed and manufactured according the CE guidelines, the actual technical standards and applicable safety rules and are marked with the CE mark.

This document is valid for the KINEMATICA Batch mixing systems **MICROTRON® MB 950 G** and **MICROTRON® MB 950 S**.

The intended use includes the following:

- Dispersing, Mixing, Homogenizing and Emulsifying of cuttable substances under the considerations and limitations given in the "Technical Data"
- The processed media must be compatible with all constructional parts wetted by the product.
- If suitable precautions to personnel are taken to prevent any harm due to noise emission.
- The use of the system with no structural, mechanical or electrical changes different from the original scope of supply.

Typical applications:

- Mixing, Dispersing, Homogenizing, Emulsifying
- Mixing of cuttable materials
- Pollutant analysis (e.g. foodstuff)
- Sample preparation for content analysis in quality control and / or quality assurance
- Prevention of excessive aeration due to closed system (MB 950 G)

If the system is used for purposes different than or over and above the capabilities specified herein, **KINEMATICA** does not guarantee proper function and assumes no obligation or liability. Should you have any questions which are not answered in this document, please contact **KINEMATICA**.

Visit [www.kinematica.ch](http://www.kinematica.ch) for your closest contact address.

System	MICROTRON®		
Type	MB 950 G / S		
Version	1.1 / 19.06.2023		
Page	11	of	32

## 2 DESCRIPTION OF THE UNIT

For a ready-to-use system you need:

- Drive Unit MICROTRON® MB 950 G or MB 950 S
- Mixing Attachment MBA
- Safety Hut MBH (only MT 950 G)



INSTRUCTION MANUAL			
System	MICROTRON®		
Type	MB 950 G / S		
Version	1.1 / 19.06.2023		
Page	12	of	32

## 2.1 Drive Unit MB 950 G / MB 950 S

The drive units are equipped with a powerful high temperature resistant collector motor with fan and integrated motor control.

The operation of the units is done through the Turn/Push knob as well as the intuitive touch display.

The drive unit MB 950 G is designed to work with the glass mixing attachments MBA 125, MBA 250, MBA 500 and MBA 1000, the MB 950 S with the stainless steel mixing attachments MBA 2000 and MBA 4000.

With the MB 950 G the safety is ensured through the respective suitable safety hut. The safety hut will be placed onto the drive unit so that the magnetic cylinder of the hut is fitted into the retainer at the drive unit and fixed through the lock screw. The unit can only be started when the safety hut is installed correctly.

With the MB 950 S the safety is ensured through the respective suitable lid of the mixing attachment. The lid has to be placed so that the small hole in the lid is placed over the end of the safety bar. Make sure that the lid closes properly.

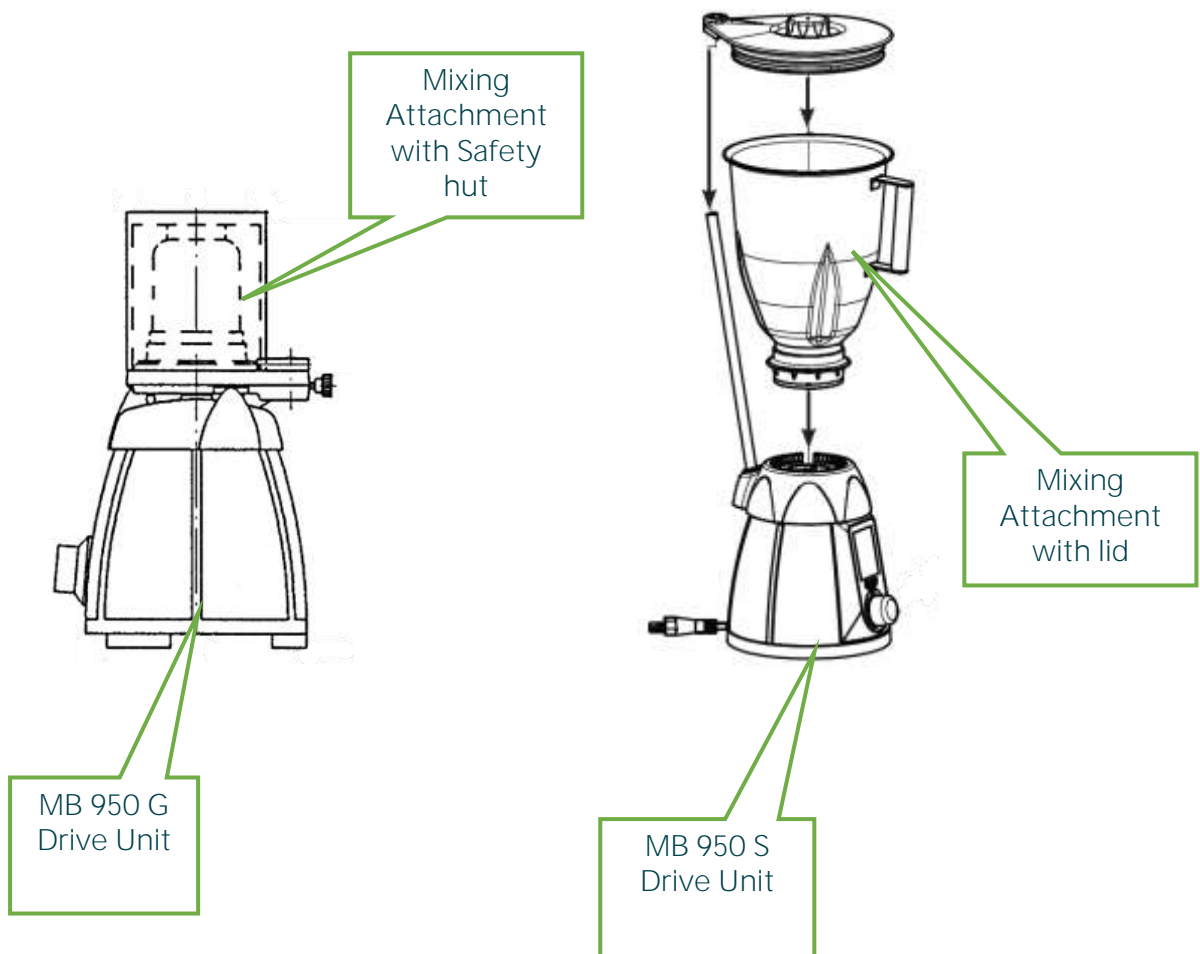

### 2.1.1 SAFETY CONTROL AND MOTOR PROTECTION

The safety features prevent the motor from being switched on without a safety hut (MB 950 G) or lid (MB 950 S) being in place, or stops the unit if the safety hut or lid is removed while the unit is working. When the hut or lid is put back on, the unit must be restarted.

To ensure that the machine is safely switched off, the power plug must be pulled out.

When the machine is overloaded or overheated, it switches off automatically.

If this occurs, after about 60 seconds, please press the black button on the bottom plate of the motor base.

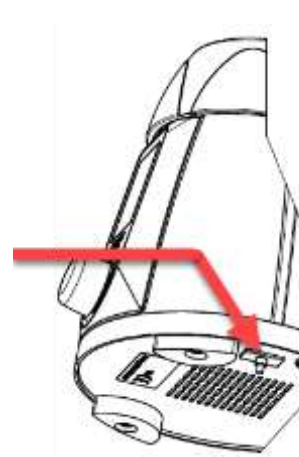

When the machine stops automatically, immediately remove the container, pull out the power plug and wait for 1 minute.

If you notice any irregularities or defects, please contact your supplier.









System	MICROTRON®		
Type	MB 950 G / S		
Version	1.1 / 19.06.2023		
Page	14	of	32













## 2.1.2 CONTROL AND DISPLAY ELEMENTS

	<p>Touchdisplay: Works simultaneously for display and control. To select a function, tap directly on the icon.</p>
	Speed display (1..10)
	Timer / stopwatch
	Pulse button
	Interval button
	Settings
Mix cycles	
<p>Turn/Push knob: On/Off button, Stop button, speed, time setting (timer function)</p>	





### 2.1.2.1 Explanation of symbols

	Increase speed		Settings
	Reduce speed		Operation mode „solids“
	Timer		Operation mode „liquids“

System	MICROTRON®		
Type	MB 950 G / S		
Version	1.1 / 19.06.2023		
Page	15	of	32

<b>+10s</b>	Extra 10 seconds		Silent mode (low noise)
	Pulse	<b>STOP</b>	Stop mix cycle
	Pulse operation to permanent		Back with save (enter)
	Interval		Back without saving (cancel)
	Mix cycle for small filling		Mixing attachment with safety hut of lid is missing
	Mix cycle for medium filling		Motor defect (Service department)
	Mix cycle for large filling		Sign: Mixer is switching to standby



**2.1.2.2 Timer Function:**

	Your mixer has a time feature, which can be used to set the duration of the mixing.	
		Tapping on the icon calls up the time menu. Now the knob can be used to set the duration between 1 second and 60 minutes. The time set remains saved.
		By turning the knob or tapping the icon saves the time entry and the mixer returns to the main menu. The blue figures symbolize the activated time and the mix cycle will be automatically stopped after the time expires.
		Tapping on the icon in the time menu deactivates the timer again (cancel). The time is deactivated after every restart.
		The duration can be set before start-up but also during the mixing, the mixer stopping after the time has expired.



System	MICROTRON®		
Type	MB 950 G / S		
Version	1.1 / 19.06.2023		
Page	16	of	32

	<b>+10s</b>	The duration can be increased by 10 seconds at any time by tapping the icon.
	<b>STOP</b>	The mixer is stopped by briefly pressing the knob or by tapping on STOP.

### 2.1.2.3 Pulse Function:





	Your mixer has a pulse / inching function.	
		The mix can be stirred up in tap mode by tapping the icon. The mixer starts up and accelerates to the highest level as long as the icon is touched.
		Swiping on the icon causes the mixer to run at the highest level without having to tap.
	<b>STOP</b>	The mixer is stopped by briefly pressing the knob or by tapping on STOP.

### 2.1.2.4 Interval Function:





	Your mixer has an interval function. Interval mode allows a more even mixing when using more viscous materials. The time features can also be used in interval mode.	
		Tapping on the icon starts interval mode at the lowest level.
		During interval mode the speed can be freely selected between lowest and highest mode, either via the knob or the icons.
	<b>STOP</b>	The mixer is stopped by briefly pressing the knob or by tapping on STOP.

System	MICROTRON®		
Type	MB 950 G / S		
Version	1.1 / 19.06.2023		
Page	17	of	32



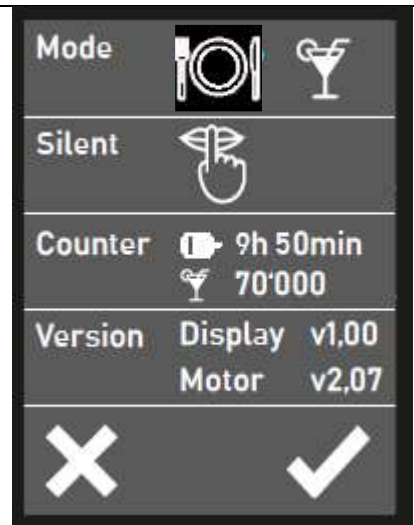

### 2.1.2.5 Mixing cycles function:

	<p>Your mixer features three different mix cycles. These allow you to start up an automatic mix cycle. Tapping one of the icons starts up the mix cycle, the mixer stopping automatically when the time has expired. The duration and form of the cycles is based on the percentage of filling quantity in the mixing attachment. The time features can also be used in interval mode.</p>
	<p>This cycle is for small quantities that have to be intensively processed in the shortest time possible (approx. 20% filling quantity).</p>
	<p>This cycle is for medium quantities with an average processing time (approx. 50% filling quantity)</p>
	<p>This cycle is for large quantities where processing requires more time (approx. 70% filling quantity)</p>
<p><b>STOP</b></p>	<p>The mixer is stopped by briefly pressing the knob or by tapping on STOP.</p>

### 2.1.2.6 Settings:

	<p>Various settings are available that allow you optimal and easy use of your mixer. The blue icon shows the active setting.</p>
	<p>Through pressing on the icon the settings page is opened.</p>
	<p>With pressing the icon the chosen settings are saved and the mixer returns to the main menu.</p>
	<p>With pressing the icon the chosen settings are not saved and the mixer returns to the main menu. The previous settings remain active.</p>
	<p>Mode „solids“. The basic settings of the unit are optimized when using products with mainly solids.</p>

System	MICROTRON®		
Type	MB 950 G / S		
Version	1.1 / 19.06.2023		
Page	18	of	32

		Mode „liquids“. The basic settings of the unit are optimized when using products with mainly liquids.
		When this function is active, the mixer is optimized for the quietest operation possible. The function can be activated in both “solids” and “liquids” mode.
	  	<p>Area Counter: The operating hours counter records the time that the motor is switched on in hours and minutes.</p> <p>The cycle counter records every start-up of the mixer.</p> <p>Both counters are registered from the first start-up and cannot be reset.</p>
		<p>Area Version: Displays the installed software version for the display control and motor control. This information is helpful for servicing.</p>



INSTRUCTION MANUAL			
System	MICROTRON®		
Type	MB 950 G / S		
Version	1.1 / 19.06.2023		
Page	19	of	32

## 2.2 MIXING ATTACHMENTS (MBA)

### 2.2.1 MBA FOR MB 950 G

For the MB 950 G four different mixing attachments with glass vessels are available with volumes from 125 ml to 1'000 ml.

Description	MBA 125	MBA 250	MBA 500	MBA 1000
Order Code	36050005	36050010	36050015	36050020
Working volume (max)	125 ml	250 ml	500 ml	1000 ml
Material vessel	Borosilicate Glass			
Material sealing	NBR, others as spare parts available on request (EPDM, Viton, Silicone)			
Material cutter	Cutter head made from stainless cutlery steel			
Autoclavable	Yes, only glass vessel			

A mixing attachment consists of:

- Mixing vessel (1)
- Cutter head with sealing ring (2, 3)
- Threaded ring (4)

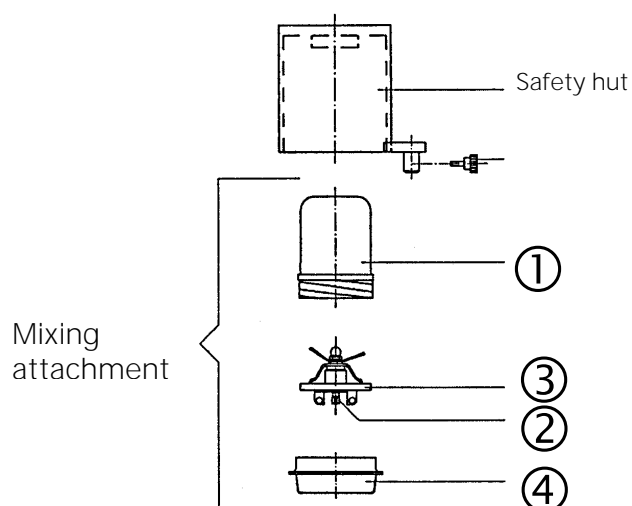

For assembly and disassembly see also next chapter.

System	MICROTRON®		
Type	MB 950 G / S		
Version	1.1 / 19.06.2023		
Page	20	of	32

## 2.2.2 MBA FOR MB 950 S

For the MB 950 S two different mixing attachments with stainless steel vessels are available with volumes 2'000 ml and 4'000 ml.

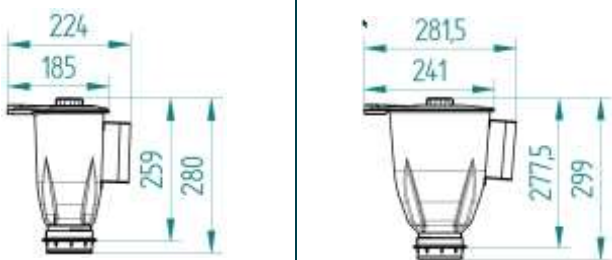
Description	MBA 2000	MBA 4000
Order Code	36050050	36050055
Working volume (max)	2000 ml	4000 ml
Material vessel		
Material sealing	Stainless steel	
Material cutter	NBR, others as spare parts available on request (EPDM, Viton, Silicone)	
Description	Cutter head made from stainless cutlery steel	
Autoclavable	Yes, only stainless steel vessel	

A mixing attachment consists of:

- Mixing vessel with lid
- Cutter head with sealing ring
- Threaded ring

### Assembly

- Insert the cutter head together with the gasket into the threaded ring.
- Screw the vessel turning counter clockwise into the threaded ring.
- Always make sure that the ring nut is screwed on straight and that the seal is evenly seated in it.
- **WARNING:** The cutter blades are sharp and may cause severe injuries.



INSTRUCTION MANUAL			
System	MICROTRON®		
Type	MB 950 G / S		
Version	1.1 / 19.06.2023		
Page	21	of	32

## Disassembly

- First remove the complete mixing attachment from the drive unit and empty it completely.
- Attention: To loosen the plastic threaded ring, turn to the right. Clockwise, like closing a water tap, as the threaded ring is left-threaded!
- Do not tear the handle (risk of breakage).



## 2.3 SAFETY HUT (MBH)

For the mixing attachments of the MB 950 G the respective suitable safety huts are available.

Description	MBH 125	MBH 250	MBH 500	MBH 1000
Order Code	36050025	36050030	36050035	36050040
Working Volume (max)	125 ml	250 ml	500 ml	1000 ml
Material	PMMA (Plexiglass)			

INSTRUCTION MANUAL			
System	MICROTRON®		
Type	MB 950 G / S		
Version	1.1 / 19.06.2023		
Page	22	of	32

## 3 INSTALLATION AND START-UP

The drive units described in this manual will be delivered completely assembled and the package will include:

- Drive unit with main cable
- Manual

The mixing attachments and safety huts will be delivered completely assembled and the respective package will include:

- Mixing attachment (according to order, optional)
- Safety hut (according to order, optional)

Other accessories or equipment will be packed separately and delivered as ordered.

Always check the delivery note and check immediately when unpacking the unit. Always report immediately any irregularities.

### 3.1 INSTALLATION

#### 3.1.1 MECHANICAL INSTALLATION

- The MICROTRON® has to be positioned on an even surface or foundation. Ensure that no vibrations can be transmitted onto the unit. Please check if there is a sufficient air circulation.

#### 3.1.2 ELECTRICAL INSTALLATION

- Before connecting the electrical power supply using the mains cable, check the "Technical Data" as well as the data on the drive tag plate.
- The unit should only be connected to a single phase grounded alternating current. Make sure that the original mains cable and the wall outlet correspond.
- For safety reasons the outlet must have a faulty-energy-protection switch (FI).
- If at all possible, avoid using an extension cord. If it is unavoidable, only proper, approved extension cords should be used. Do not subject the main cable to strong tension or pressure.

System	MICROTRON®		
Type	MB 950 G / S		
Version	1.1 / 19.06.2023		
Page	23	of	32

### 3.2 START-UP

- Before starting up the unit make sure to have read and understood this manual. Especially chapter 2 to understand the different parts and functions of the unit.
- Before using the unit for the first time it must be thoroughly cleaned. Follow the instructions in the chapter „Cleaning“.
- Place the chosen mixing attachment onto the drive unit. The mixing attachments and the glass vessels respectively will be filled with the product to be processed and closed with cutting head / threaded ring prior to placing on the drive unit. The mixing attachments of the MB 950 S are normally first placed onto the drive unit and then filled.
- With the MB 950 G place the safety hut onto the drive unit so that the magnetic cylinder of the hut is fitted into the retainer at the drive unit and fixed through the lock screw.
- With the MB 950 S place the lid onto the vessel so that the small hole in the lid is placed over the end of the safety bar. Make sure that the lid closes properly.

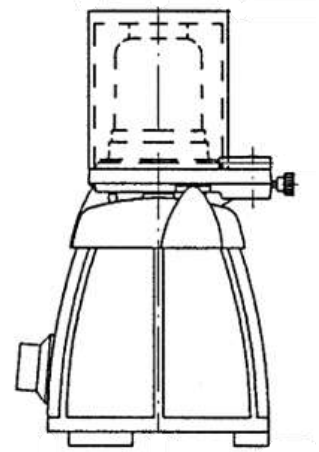



System	MICROTRON®		
Type	MB 950 G / S		
Version	1.1 / 19.06.2023		
Page	24	of	32

- Pressing the knob turns the machine on. During start-up a ring appears in the display, followed by the main menu.

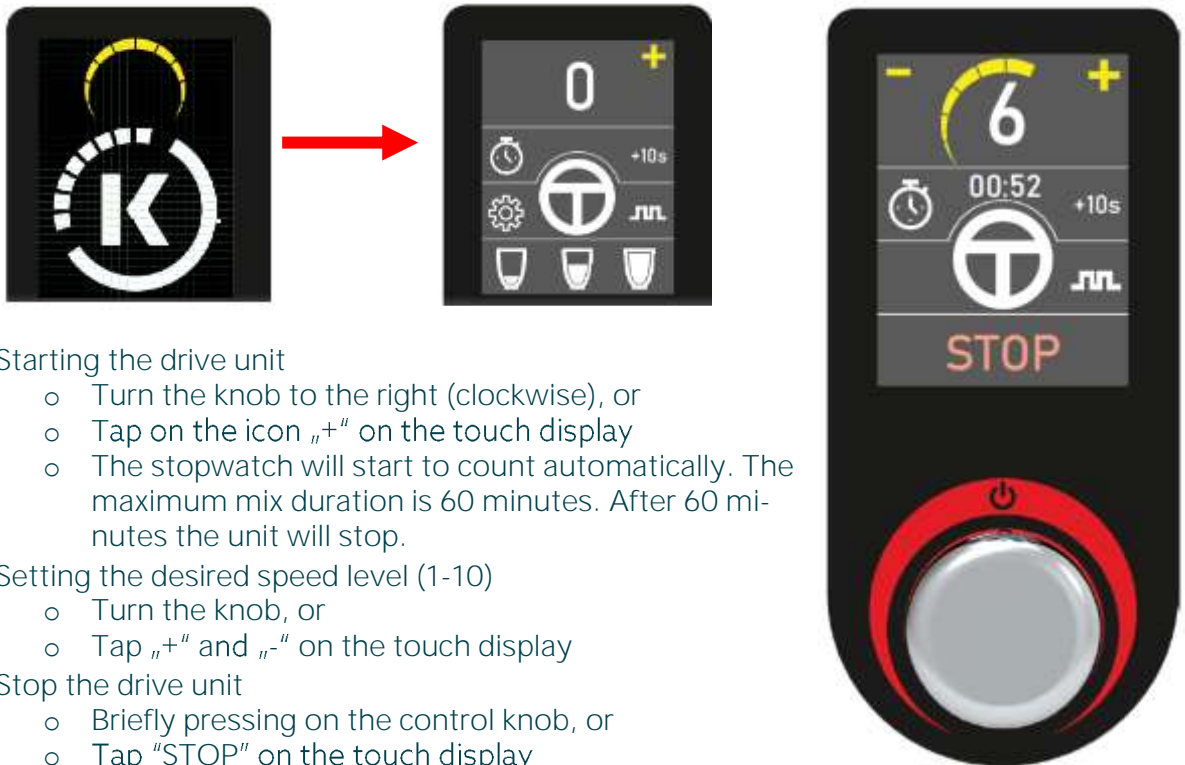

- Starting the drive unit
  - Turn the knob to the right (clockwise), or
  - Tap on the icon „+“ on the touch display
  - The stopwatch will start to count automatically. The maximum mix duration is 60 minutes. After 60 minutes the unit will stop.
- Setting the desired speed level (1-10)
  - Turn the knob, or
  - Tap „+“ and „-“ on the touch display
- Stop the drive unit
  - Briefly pressing on the control knob, or
  - Tap „STOP“ on the touch display
- Notes:
  - The motor only runs if the safety hut or lid is in correct position!
  - Keeping the control knob pressed (for more than 2 seconds) will switch the unit to standby.
  - After 60 minutes without activation, the mixer automatically shuts down. The automatic shutdown is announced beforehand with the „SLEEP“ icon.
  - Particularly in the case of thick, viscous materials, the highest possible speed should be selected so that the motor is not heated up unnecessarily.
  - MB 950 S: Liquids and fine grained materials can be added through the filler opening in the lid of the container during operation (Remove the lid lock).
  - MB 950 S: By switching on and operating at high speed, it is recommended that the vessel should be held (lay hand on the lid).
  - The windings of the Rotor commutator motors are covered with high-quality insulating lacquer. For this reason, the motor may, at first, exude an odour when it heats up. This is normal and does not damage the motor; it disappears after the motor has been used several times.



INSTRUCTION MANUAL			
System	MICROTRON®		
Type	MB 950 G / S		
Version	1.1 / 19.06.2023		
Page	25	of	32

## 4 CLEANING

- The unit and the mixing attachment respectively have to be cleaned thoroughly after every use. Incorrect and careless cleaning can heighten the risk of growing micro-organisms considerably.
- If the processed media tends to harden or stick, the product has to be removed completely from the mixing attachment after every use

Drive Unit	The motor unit must never be submerged in, or sprayed with water or any other liquid! Never attempt to clean it with a water jet!
	Cleaning of the inside should only be made at an authorized service centre.
	If necessary, clean the motor unit with a damp cloth, first unplug the unit from the power supply.
Mixing Attachment	The mixing attachment has to be disassembled for cleaning. The vessel can be cleaned in the dishwasher or with hot water and commercially available detergent.
Glass vessel	<p>The mixing vessels are made from borosilicate glass and are therefore autoclavable. Borosilicate glass has very good chemical and physical properties and is used for applications where in addition to the very good chemical resistance, a very high heat resistance and thermal shock resistance and high mechanical strength are required (e.g. round-bottomed flasks, beakers).</p> <p>Upon heating of the flask no deformations are to be expected up to 400° C, however, they already occur at lower temperatures due to the thermal expansion and the poor thermal conductivity of tensile and compression stresses. If the permissible strength values are exceeded as a result to rapid heating or cooling rates, fracturing occurs. Therefore - as with any glass - a maximum permissible temperature can not generally be defined. If the flask is evenly and slowly heated up in the autoclave and then correspondingly cooled off, then no problems should be expected for example at 135° C.</p> <p>Never heat the vessel on a hotplate and never expose it to abrupt temperature changes (e.g. don't take it hot out of the drying cabinet and put on a cold or wet lab table).</p>

System	MICROTRON®		
Type	MB 950 G / S		
Version	1.1 / 19.06.2023		
Page	26	of	32

Stainless steel vessel	<p>For example, with applications in laboratories even the stainless steel parts can reach their limits concerning chemical resistance when they come into contact with chlorides (e.g. hydrochloric acid). The initial drying of chloride-containing disinfectants or the evaporation of hydrochloric acid-containing floor cleaner or similar can lead to chloride-induced pitting on the surface of the stainless steel. Such disinfectants should be sufficiently rinsed off after the prescribed contact time. Alternatively, chloride-free disinfectants can be used. Hydrochloric acid-containing cleaners should be avoided. Improper use (e.g. inadequate rinsing) of active chlorine-containing cleaning agents, leads to pitting. Any stainless steel can corrode under adverse conditions. Outside rust is caused by iron particles that attach themselves to the steel surface.</p> <p>The source of the particles can be:</p> <ul style="list-style-type: none"> <li>• The water supply</li> <li>• Steel wool sponges, with which the dishes were pre-cleaned</li> <li>• Paper clips, drill cuttings, screws, etc., just to name a few.</li> </ul> <p>Since all of these parts are introduced from the outside, it is called outside rust. If the rust spots and its source can not be directly removed, corrosion damage can occur increasingly.</p>
Threaded ring	<p>The black threaded ring (mostly does not come into contact with the product) is resistant up to 115° C and has a good resistance in the dishwasher. The inside of the threaded ring is best cleaned with a stiff brush.</p>
Cutter head	<p>simply rinse and, if necessary, scrub off. Never place into water or the dishwasher.</p>
Dampers	<p>The shock absorbers on the bottom of the cutter head are made of H-NBR (max. 140° C, cleaning with hot water and steam also possible) and the hard-paper cover plates on both sides of the bearings are based on phenolic resin and tolerate at most 120° C.</p>
Vessel sealing	<p>The vessel seal (gray ring) is standard NBR (max. 90° C, FDA, ideal for the food industry, resistant to gasoline, oils, weak acids, and bases). For special requirements (laboratory applications), the seals can be supplied in special materials that have a higher chemical and thermal resistance:</p> <ul style="list-style-type: none"> <li>• Viton (can withstand approximately 200° C, ideal for chemical applications, excellent resistance to aromatic solvents)</li> <li>• EPDM (up to 150° C, industrial applications, especially for hot water and steam)</li> <li>• Silicone rubber (max. 200° C, FDA, for the food and pharmaceutical industries)</li> </ul>

System	MICROTRON®		
Type	MB 950 G / S		
Version	1.1 / 19.06.2023		
Page	27	of	32

Safety hut	<p>Chemically-speaking, Plexiglas® (brand name) is a product made from polymethylmethacrylate, abbreviation PMMA, which is also known as acrylic glass.</p> <p>Plastics can generally become electrostatically charged. This can cause the parts to then attract dust. Outdoors, this phenomenon is normally prevented by the rain and humidity. The phenomenon can also be promoted by mechanical rubbing of the plastic surfaces, air movement, and dry air with plastic parts indoors.</p> <p>To clean the safety huts, which are not directly in contact with the product, use only a microfiber cloth lightly dampened with water.</p> <p><b>As a basic principle, no alcohol or solvents should be used to clean PMMA!</b></p>
------------	--

INSTRUCTION MANUAL			
System	MICROTRON®		
Type	MB 950 G / S		
Version	1.1 / 19.06.2023		
Page	28	of	32

## 5 MAINTENANCE WORK

- The drive unit is almost maintenance free. Nevertheless to guarantee a long lifetime the unit should always be used with care.
- The motor bearings are permanently lubricated and therefore require no maintenance.
- The cutter head bearing is heavily loaded. Replace cutter head when loose or becomes noisy (wear part).

### WEEKLY INSPECTION

If one of the following irregularities is found during inspection, the unit has to be stopped immediately and repaired:

- Check on a weekly basis whether this icon appears if the cover is removed after the machine is switched on (speed "0"), otherwise repair by our service department is required.



### 5.1 REPAIR

Obtain the address of your nearest Kinematica authorized service center, from the supplier where you purchased your unit.

When returning the unit for repairs use a shockproof packing and well upholster the unit !

Repairs on electrical appliances should only be carried out by professional technicians. Use only genuine spare parts. Serious dangers to the user could result from improper carried out repairs.

#### Attention!

If the unit's mains cable should become damaged, it should only be replaced with an original cable (service centre).

### 5.2 DISPOSAL / RECYCLING



The symbol of the crossed refuse container signifies that the product in the European Union to must be supplied to separate collection. Labeled products must not be disposed with household waste, rather must be left at a collection point for recycling electrical and electronic equipment. Recycling helps to reduce the consumption of raw materials and to protect the environment.





## 6 SPARE PARTS

Only original KINEMATICA spare parts will guarantee a trouble-free operation of the unit. Please bear in mind that some components have lead times of several weeks.

Don't hesitate to contact KINEMATICA for a corresponding quotation or advise.

## 7 FAULTS AND REMEDIES

Fehler	Mögliche Ursachen	Lösung
Mixer yield unsatisfactory.	Blades are worn out.	Replace cutter head.
	The mixer is in "Silent Mode".	Deactivate "Silent Mode" in the settings.
The icon "No mixing attachment" is displayed. 	The mixing attachment / safety hut or the lid has not been placed.	Place the mixing attachment / safety hut or the lid correctly.
The motor continues to run even after the safety hut or lid has been lifted.	Defective safety switch or electronics.	Risk of accident! Repair through service centre.
The "motor faulty" icon is displayed and the machine will not run. 	Carbons at motor are worn out.	Repair through service centre.
	The motor or speed monitor is faulty.	Repair through service centre.
The motor only runs at highest speed.	Defective electronics.	Repair through service centre.

INSTRUCTION MANUAL			
System	MICROTRON®		
Type	MB 950 G / S		
Version	1.1 / 19.06.2023		
Page	30	of	32

The motor is difficult or impossible to adjust.	Defective electronics.	Repair through service centre.
The motor stops under load.	Overload.	Press overload switch.
	Carbons at motor are worn out.	Repair through service centre.
	Defective electronics.	Repair through service centre.

INSTRUCTION MANUAL			
System	MICROTRON®		
Type	MB 950 G / S		
Version	1.1 / 19.06.2023		
Page	31	of	32

## 8 TECHNICAL DATA

### 8.1 DRIVE UNITS

Description	<ul style="list-style-type: none"> <li>Drive unit MICROTRON® MB 950 G / 950 S</li> </ul>			
Order Code MB 950 G	36010151	36010150	36010152	36010153
Order Code MB 950 S	36010161	36010160	36010162	36010163
Plug type	CH	EU	UK	US
Power Supply	<ul style="list-style-type: none"> <li>1-phase, 230 V / 50-60 Hz / 4.2 A</li> </ul>			1ph 120 V / 60 Hz / 7 A
Input Power	<ul style="list-style-type: none"> <li>Max. 950 W for continuous operation</li> </ul>			
Motor type	<ul style="list-style-type: none"> <li>High temperature resistant collector motor with fan</li> </ul>			
Motor control	<ul style="list-style-type: none"> <li>smooth, gradient starting</li> <li>infinitely variable speed adjustment between 1000...17'000 rpm</li> <li>electronically controlled speed stabilization (actual and desired value comparison)</li> <li>the motor has a thermal protection switch and is electronically monitored</li> </ul>			
Electrical equipment	<ul style="list-style-type: none"> <li>safety control system for lid monitor</li> <li>grounded with additional double insulation according to standard EN 60335-1</li> <li>electromagnetically shielded accordance</li> </ul>			
Construction	<ul style="list-style-type: none"> <li>Motor base is constructed of chromium-plated casting</li> </ul>			
Noise emissions (drive only)	<ul style="list-style-type: none"> <li>76 dB(A)</li> </ul>			
Ambient conditions	<ul style="list-style-type: none"> <li>+10 .. +40 °C (Lagerung -20 .. +70°C)</li> <li>0 .. 2000 m ü.M.</li> </ul>			
Relative Humidity	<ul style="list-style-type: none"> <li>Max 80 % (storage 95%) non condensing</li> </ul>			
Standards	<ul style="list-style-type: none"> <li>Designed and manufactured according EN/IEC standards for EMC &amp; Safety</li> </ul>			
Weight / Dimensions (drive only)	<ul style="list-style-type: none"> <li>Approx. 5.8 kg</li> <li>Approx. Ø 194 x 226 mm</li> </ul>			

INSTRUCTION MANUAL			
System	MICROTRON®		
Type	MB 950 G / S		
Version	1.1 / 19.06.2023		
Page	32	of	32

## 9 WARRANTY

KINEMATICA AG guarantees that the equipment that it produces will run free of any fault related to materials or manufacturing faults for **24 months**.

### ADDITIONAL WARRANTY FOLLOWING REGISTRATION

Consumers who complete a warranty registration within 20 days of receiving their device will benefit from a free warranty extension of a further 12 months. This means that the total warranty period after registration is 36 months.

## REGISTER NOW



[kinematica.ch/warranty-upgrade](https://www.kinematica.ch/warranty-upgrade)

If thorough testing shows a fault to be due to either of the above causes, KINEMATICA AG guarantees that the equipment will be repaired or replaced free of charge. The guarantee does not cover parts that are subject to normal wear. It is void if any person other than an employee of KINEMATICA AG or their appointed representative has made modifications to the equipment or if the damage is due to failure to comply with the operating instructions, to carelessness, accident, incorrect use or incorrect supply voltage.

Please check our further warranty conditions and the correct procedure for a repair application on our website:

<https://www.kinematica.ch/en/Service/service-repair>

KINEMATICA AG reserves the right to make technical changes to the equipment without modifying equipment delivered earlier in the same way.

In the event of technical problems, for spare parts requirements or for advice, contact our regional appointed agent, your preferred dealer or us directly at:

**KINEMATICA AG**  
Werkstrasse 7, C-D  
CH-6102 Malters  
Schweiz

Tel. +41-41-259 65 65  
Fax +41-41-259 65 75  
E-Mail [service@kinematica.ch](mailto:service@kinematica.ch)